

# Commercial Hot Water Systems

125 Years  Bosch  
1886-2011



**BOSCH**  
Invented for life



For hot water, Bosch is the number one choice for your building projects.

## Contents

- 3** Professional Series
- 4** 32 Series
- 6** 32C Commercial Condensing
- 8** 32C Commercial Condensing Accessories
- 10** Commercial Manifold Packs
- 12** Manifold Ring Main Kit
- 13** Manifold Tank Kit
- 14** Commercial Accessories
- 16** Commercial Manifold Pack Accessories
- 18** Professional Packs
- 20** Commercial Tanks
- 21** Commercial System Selection Guide
- 22** Product Specifications Commercial Manifold Pack (32)
- 23** Product Specifications Commercial Manifold Pack (32C)





# Bosch Professional Series<sup>#</sup>

## the first choice for Builders

The latest project model, the Bosch Professional hot water system has been specifically designed for maximum energy efficiency and ease of installation for your building projects.

Whether building a new home, or replacing an existing hot water system as part of a renovation, a Bosch Professional provides uncompromised quality while being compact, space-saving and easy to install. The Bosch Professional has a 5.56 star energy efficiency rating and in addition to being energy efficient, is also cost effective.

Being 50°C limited, there is no need for additional tempering valves for the hot water outlets.

Optional accessories for the Bosch Professional Range include:

- ▶ Lockable Recess Box - RBHF50L
- ▶ Fully Enclosed Recess Box - FERB70
- ▶ Pipe Cover - YPHC304
- ▶ Security Bracket - BLB70

*For other domestic options please refer to the Bosch Domestic Brochure.*

<sup>#</sup>Not available in New Zealand.

### Features:

- ▶ 50°C temperature limited<sup>#</sup>
- ▶ 5.56 star energy efficiency rating
- ▶ Easy installation
- ▶ Compact design
- ▶ Optional temperature controllers (up to 4)
- ▶ Available in Natural or LP Gas
- ▶ Comprehensive domestic warranties



### Bosch Professional (21L/min)

#### Specifications

	Model
	<b>Bosch Professional</b>
Part Number	YS2170RA5P
Installation	External
Ignition	Electronic
L/min (25°C rise)	21
L/min (20°C rise)	26
Min. operating inlet water pressure (kPa)	100
Max. inlet water pressure (kPa)	1000
Mj/H	170
Star Rating	5.56
Temperature	50°C limited
Min. Flow (L/Min)	2.5
Min. constant water pressure for Max flow (kPa)	130
Antifrost	Standard
Gas Type	NG/LPG
Electrical Supply	230 - 240 VAC 50 Hz (10amp weatherproof powerpoint required within 500mm of the unit)
Temperature Controller	Up to 4 temperature controllers can be installed (Standard Controllers: YPRM66XB, YPRS66XB; Premium Controllers: YPRM67XB, YPRS67XB; Sub-Controller: YPRP62XB)
Unit Height x Width x Depth (mm)	520 x 350 x 170
Carton Weight (kg)	19
<b>Domestic Warranty</b>	
Parts & Labour	3 Years
Heat Exchanger (part only)	10 Years
<b>Pipe Connection Sizes</b>	
Natural Gas	20mm (3/4")
LP Gas	20mm (3/4")
Cold Water	20mm (3/4")
Hot Water	20mm (3/4")

# Bosch 32 Series



**Bosch 32**



**Bosch 32Q**

The Bosch 32 Series provides flexibility and reliability when there is demand for large volumes of hot water.

The Bosch 32 Series has been specifically designed for Australian and New Zealand commercial use. Both the 32 and 32Q contain a 25% thicker commercial grade heat exchanger to aid in preventing corrosion and deterioration.

The Bosch 32 Series will, with a controller attached, reactivate within one minute of power returning after an outage, and will return to the same selected temperature settings it had prior to the loss of power.

Ideally suited to commercial applications, the Bosch 32 can be installed as a single unit or in multiple unit manifolded configurations with the use of the quick connect cord (KMQC0703339) for 2 units, or the systems controller (KMSC201) for 3 to 6 units. Please see page 10 for more information on the Bosch Manifold Pack and pages 22-23 for a listing of Manifold Pack Specifications.

## Installation Options

The Bosch 32 Series offers the unique ability to be installed internally\*, or externally with the Bosch Vent Cap (KMVC-100). Please refer to page 14 to view the extensive range of Bosch Commercial Accessories.

These exclusive installation options make the Bosch 32 Series the most flexible Bosch units available.

*Bosch also offers a Commercial Condensing appliance, the Bosch 32C, see page 6.*

\*Internal installation of the Bosch 32 Series requires flueing and adequate ventilation, see page 14.

\*\*External installation of the Bosch 32 Series requires the KMVC-100 Vent Cap, see page 14.

## Specifications

	Model	
	Bosch 32	Bosch 32Q
Part Number	KM3211WH	KM3211WHQ
Installation	Internal* or External**	Internal* or External**
L/min (25° C rise)	32	32
Min. Flow (L/min)	3.5	3.5
Min. pressure for max flow (kPa)	200	200
Max. allowable inlet water pressure (kPa)	900	900
Antifrost	Standard	Standard
Gas Input—Low (Mj/H)	25	25
Gas Input—High (Mj/H)	250	250
Star Rating	4.8	4.8
Air Supply / Exhaust	Power Flued	Power Flued
In-built recirculation pump	No	Yes
Gas Type	NG/LPG	NG/LPG
Electrical Supply	240 VAC	240 VAC
Power Consumption	NG - 100W / LP - 115W / AF - 115W	NG - 135W / LP - 150W / AF - 115W
Temperature Controller	Compatible with RCM3211 and RCS3211 (Maximum of 3)	
Unit Height x Width x Depth (mm)	615 x 464 x 240	615 x 464 x 240
Unit Weight (kg)	29	32
Warranty	Commercial – 2 years parts and labour, 5 years heat exchanger (part only) Domestic – 3 years parts and labour, 10 years heat exchanger (part only)	
<b>Pipe Connection Size</b>		
Gas Inlet	20mm (3/4")	20mm (3/4")
Water Inlet	20mm (3/4")	20mm (3/4")
Hot Water Outlet	20mm (3/4")	20mm (3/4")
Hot Water Return	–	15mm (1/2")

Bosch commercial hot water products are well-known for their quality, reliability, and excellent technical support. This will give you the confidence to always recommend Bosch to your customers.

The schematic below shows a Bosch 32Q on a ring main. The recirculation pipe is up to 60 metres in length with 20 bends, 3/4 inch flow, 1/2 inch return, and insulation on the pipework meeting R3 standard or above.

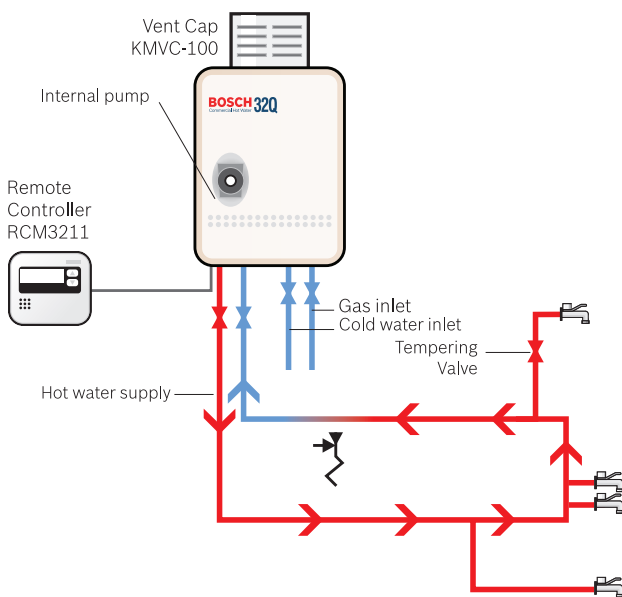

Note: Diagram is for illustration purposes only and is not drawn to scale.

#### Features:

- ▶ Bosch 32 can be manifolded
- ▶ Simple installation
- ▶ Delivers 32 litres of hot water per minute
- ▶ Natural or LP Gas
- ▶ Internal\* or external\*\* installation available
- ▶ 5 year commercial warranty on heat exchanger (part only)
- ▶ 2 year commercial warranty on full parts and labour

#### The Bosch 32Q has all the features of the Bosch 32, PLUS...

- ▶ When used on a ring main, an internal pump^ allows for programmed water recirculation in peak usage times. This results in fast delivery of hot water to your taps, with minimal water wastage.
- ▶ One main Remote Controller (RCM3211) included as standard.

^The Bosch 32Q internal pump does not have sufficient capacity to be used with a storage tank.



# Bosch 32C Commercial Condensing



**Bosch 32C**

The Bosch 32C sits at the top of the Bosch range as the most efficient commercial gas hot water unit available. It boasts superior energy efficiency of 94% and a 6 star energy efficiency rating.

The Bosch 32C is suited to both commercial and domestic application – anywhere there is demand for large volumes of hot water. The Bosch 32C is the only unit in its class that can be installed internally\* or externally\*\*.

The Bosch 32C features superior commercial-grade components throughout, including a 25% thicker heat exchanger fused with a 100% stainless steel corrosion-resistant heat exchanger. The 32C can operate as a single unit or be easily manifolded to suit a range of applications, using various Bosch accessories (see pages 16 and 17).

\*Internal installation of the Bosch 32C requires flueing and adequate ventilation, see page 8.

\*\*External installation of the Bosch 32C requires the BCVC-100C Vent Cap, see page 8.

## How does Condensing Technology work?

Unlike traditional hot water systems, Bosch condensing units capture heat from the exhaust gas and use it to preheat incoming cold water, making the Bosch 32C the most energy efficient Bosch commercial gas hot water system available!

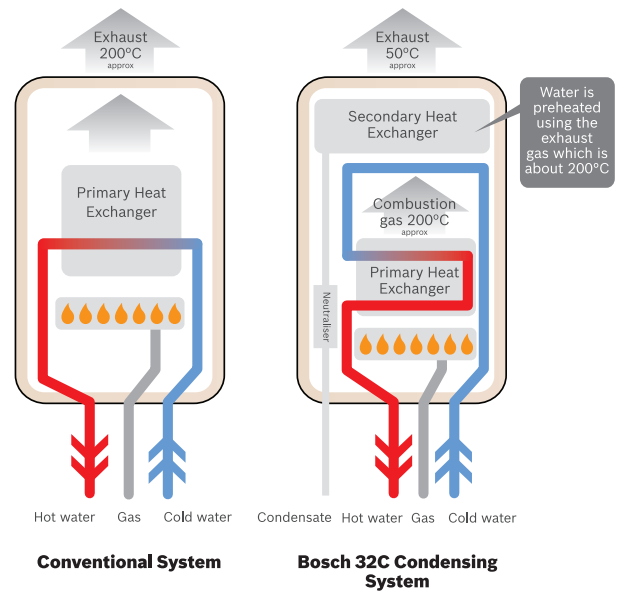

Note: Diagram is for illustration purposes only, connection position may vary.



Following the success of the Bosch 26<sup>eco+</sup> being named the 2009 Australian Plumbing Industry Green Product of the Year, Bosch developed the Commercial Condensing 32C – the only commercial condensing hot water system on the market.

#### Features:

- ▶ 6-star energy efficiency rating – the most efficient Bosch commercial gas hot water available, with 94% energy efficiency
- ▶ 217 Mj/H gas consumption, producing a flow rate of 32 litres per minute at a 25°C rise
- ▶ Designed to run up to 18 hours per day
- ▶ Can be installed internally\* or externally\*\*
- ▶ 25% thicker commercial-grade copper heat exchanger, fused with 100% stainless steel corrosion-resistant secondary heat exchanger
- ▶ Commercial-grade components used, including heavy duty resin-coated printed circuit board for increased durability and protection from the environment
- ▶ Can be installed as a single unit, manifolded, or in combination with a storage tank. Self-diagnostic electronic staging and rotation system (in manifold)
- ▶ In-built neutraliser for the safe release of condensate (pH-neutral condensate)
- ▶ Up to three temperature controllers can be installed
- ▶ Available in 37°C to 85°C temperature range (without temperature controllers), 37°C to 80°C temperature range (with temperature controllers), or available as a 50°C limited model<sup>#</sup>
- ▶ Compatible with solar hot water and warm water return systems<sup>^</sup>
- ▶ Comprehensive commercial and domestic warranties

#### Specifications

	Model
	<b>Bosch 32C</b>
Part Number	BC3200RA
50°C Limited Part Number	BC3200RA5 <sup>#</sup>
Installation	Internal* or External**
Ignition	Electronic
L/min (25°C rise)	32
L/min (20°C rise)	38
Min. inlet water pressure (kPa)	200
Max. inlet water pressure (kPa)	900
Mj/H	217
Star Rating	6
Min. Flow (L/Min)	2.5
Min. pressure for Max flow (kPa)	200
Antifrost	Standard
Gas Type	NG/LPG
Electrical Supply	230 - 240 VAC 50 Hz (10amp weatherproof powerpoint required within 500mm of the unit)
Temperature Controller	Compatible with RCM3211 and RCS3211 (Maximum of 3)
Unit Height x Width x Depth (mm)	615 x 464 x 240
Carton Weight (kg)	39
Warranty	Commercial – 2 years parts and labour, 5 years heat exchanger (part only) Domestic – 3 years parts and labour, 10 years heat exchanger (part only)
<b>Pipe Connection Sizes</b>	
Natural Gas	20mm (3/4")
LP Gas	20mm (3/4")
Cold Water	20mm (3/4")
Hot Water	20mm (3/4")
Condensate Drain	15mm (1/2")

\*Internal installations of the Bosch 32C require flueing and adequate ventilation, see page 8.

\*\*External installations of the Bosch 32C require the BCVC-100C Vent Cap, see page 8.

<sup>^</sup>Reduced condensing efficiency due to warm water input.

<sup>#</sup>Not available in New Zealand.

# Bosch 32C Commercial Condensing Accessories



One of the unique features of the Bosch 32C is it's ability to be installed internally or externally.



## Internal Installation

### Bosch 32C Flue Components

For internal installations of the Bosch 32C, flueing is required which is supplied exclusively by Bosch. These high quality flue components are made from a combination of polypropylene (PP) and aluminium, making them corrosion resistant, and easy to install. The 32C flueing system is cost effective and includes easy push-fit joints, lightweight components, and vertical or horizontal flue terminals. Internal installations of the Bosch 32C require adequate ventilation as per AS5601 and NZ5261.

Part Number	Product Description
MG85176	PP extension pipe, 100 x 500mm
MG85177	PP extension pipe, 100 x 1000mm
MG85181	PP flue elbow, 90 degrees, 100mm diameter
MG85182	PP flue elbow, 45 degrees, 100mm diameter
MG84631	Wall bracket suitable for 32C flueing
MG87930	Horizontal Wall Terminal, PP & aluminium, 100mm diameter
MG84862	Vertical Roof Terminal, PP, 100/150mm diameter incl. air cover MG75439
MG27356	Sealing Ring, please note: 1 unit required for every internal installation

## Bosch 32C flueing installation example

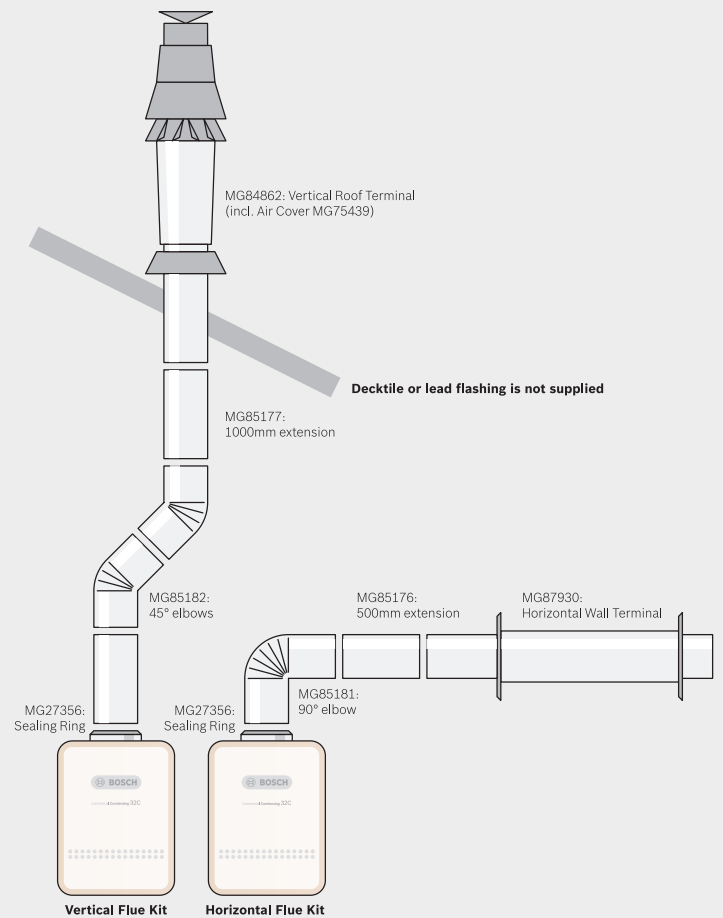

Note: Diagram is for illustration purposes only and is not drawn to scale.



## External Installation

### 32C Vent Cap BCVC-100C

- Includes flue collar



Parkview Hotel, St Kilda Road, Melbourne.



# Bosch Commercial Manifold Packs



Because no two commercial projects are the same, Bosch offers a versatile range of manifold systems that will suit your unique specification.

A Bosch Commercial Manifold Pack can consist of 2 to 6 Commercial continuous flow water heaters (Bosch 32 or 32C units only) plumbed together to allow higher flow rates than a single unit can provide.

### How are Bosch Manifold Packs supplied?

The Bosch Commercial Manifold Pack is fully assembled on a custom engineered frame. Pipework and heavy insulation including isolating valves are already installed ready to be plumbed into your specific commercial project.

Supplied in a modular system of 2 and 3 units, the Bosch Commercial Manifold Pack is packed in heavy duty separate timber crates for ease of transport and handling. The Bosch Commercial Manifold Packs of 4, 5 and 6 units are supplied in combinations of 2 and 3 unit modules as required for

your application. For example, a Bosch Commercial Manifold Pack of 6 will be supplied as 2 modular packs of 3, with a connection kit to join the pre-packaged manifolds together (BCK32 – side by side installation only).

Up to 24 Bosch Commercial units can be manifolded electronically. For more information, please contact your Bosch Commercial Sales Representative.

For a complete list of the Bosch Commercial Manifold Pack Specifications, see pages 22 and 23.

\*Internal installations require flueing and adequate ventilation. Refer to page 14 for the Bosch 32 or page 8 for the Bosch 32C flueing components.

\*\*External installations require a Vent Cap. Refer to page 14 for the Bosch 32 Vent Cap or page 8 for the Bosch 32C Vent Cap.

### Features:





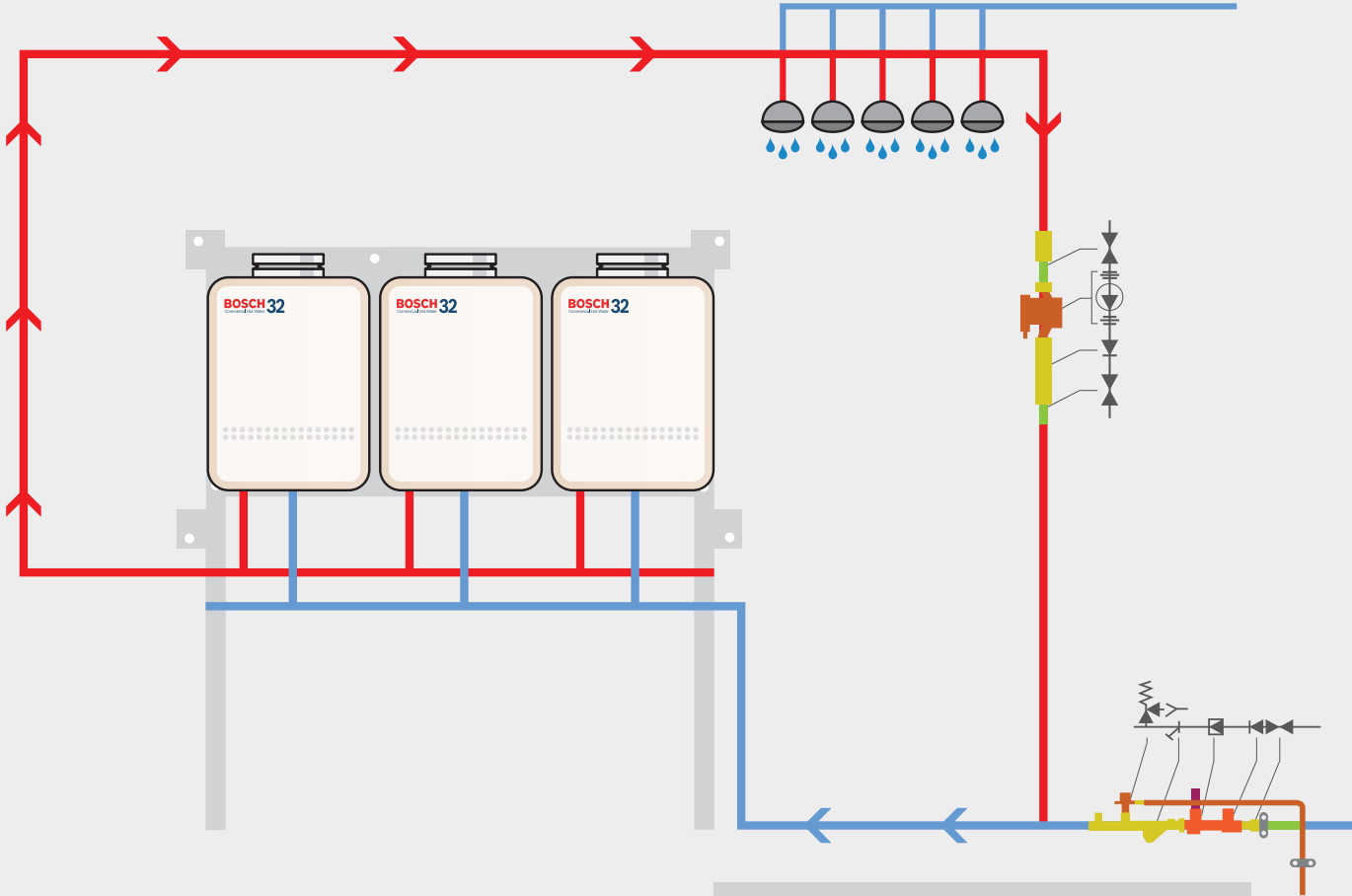



- ▶ Available with Bosch 32 and 32C units
- ▶ Internal\* or external\*\* installation
- ▶ Flexible modular design for easy pre-plumbed installation
- ▶ Sophisticated electronic staging and rotation system for extended life of the system
- ▶ 6 units in manifold pack capacity (192 litres per minute at a 25°C rise)
- ▶ Higher Mj/H rating to allow higher flow rates for commercial demand
- ▶ Strong custom frame – wall or floor mounted
- ▶ Heavy duty timber packaging to prevent delivery damage
- ▶ Available in packs of 2 or 3 units with the ability to interconnect to make 4, 5 or 6 units
- ▶ Durable weatherproof insulation on pipework to minimise heat loss
- ▶ Constant outlet temperature even when the flow rate varies
- ▶ No gas consumption when not in use
- ▶ Can be used either in standard or recirculation installations (please note, a recirculation pump needs to be installed for the ring main and it must have correct pump sizing for recirculation system – see page 12)
- ▶ Main Controller included for easy system diagnostics
- ▶ Comprehensive commercial warranties
- ▶ Applications for Manifold Packs include: sporting clubs, restaurants, commercial kitchens, cafés and pubs, hotels, commercial laundries etc

### Typical Bosch Manifold Pack Installation



This installation diagram serves as a guide only and is not drawn to scale. Please refer to installation instructions and local authority guidelines, or contact a Bosch Commercial Sales Representative when designing systems.

**Legend**

 Isolation valve	 Pressure relief valve
 Non-return valve	 Tundish
 Pressure limiting valve	 Pump
 Filter (in-line)	 Connectors



# Bosch Manifold Ring Main Kit#

The Bosch Commercial Ring Main Kit (BRMK32) easily connects the Manifold Pack to a Ring Main.

## Components of BRMK32:

- ▶ Wilo-Star Z20/7-3 pump
- ▶ Non-return valve
- ▶ Isolation valve
- ▶ Connectors
- ▶ Pipe fittings



## Sizing guide for Bosch Manifold Ring Main Kit (BRMK32) & Manifold Packs

Model	Gas Rate Mj/H Non-condensing	Model	Gas Rate Mj/H Condensing	Tropical		Coastal		Inland		Alpine	
Manifold Pack (32)		Manifold Pack (32C)		Number of showers	Flow @ 20°C rise L/min	Number of showers	Flow @ 25°C rise L/min	Number of showers	Flow @ 35°C rise L/min	Number of showers	Flow @ 45°C rise L/min
WBM2	500	WBCC2	434	8 to 9	74	7 to 8	64	5	45.7	4	35.6
WBM3	750	WBCC3	651	12 to 13	111	10 to 11	96	7 to 8	68.55	6	53.4
WBM4	1000	WBCC4	686	16 to 17	148	14 to 15	128	10	91.4	8	71.2
WBM5	1250	WBCC5	1085	20 to 21	185	17 to 18	160	12 to 13	114.25	10	89
WBM6	1500	WBCC6	1302	24 to 25	222	21	192	15	137.1	12	106.8

Note: All Bosch Manifold Systems come with electronic staging and rotation included.

### What information do I need?

1. Inlet water temperature  
[eg: average temperature, see list at right]

2. Temperature required at outlets  
[eg: 40°C for showers]

### Average inlet water temperatures:

Brisbane	20°C
Sydney	15°C
Canberra	12°C
Melbourne	13°C
Adelaide	14°C
Perth	18°C

### Calculation:

Eg: for Sydney, temperature rise = 25°C  
[40°C minus 15°C]

The simultaneous flow rate required for 6 showers = 63 L/min [7 x 9L/min AAA].  
Therefore, the correct system choice = WBM2 or WBCC2 Manifold Kit.

For more information on the Bosch Ring Main Kit, see page 17.

#Not available in New Zealand.

# Bosch Manifold Tank Kit#

The Bosch Commercial Manifold Tank Kits are supplied in component form which is then assembled onsite, making it easier to transport in lifts to rooftops or basement installations. The quick recovery times of this system make it a perfect solution for large apartment blocks and hotels.



## Bosch Commercial Manifold Tank Kit

### Commercial Pump Kit:

- ▶ Lowara 2HMS3 pump with lead, which plugs into digital thermostat ALPHASTATPLUSWR (see page 16)
- ▶ Pipes with weatherproof insulation
- ▶ Connectors

### Pump:

- ▶ 32mm inlet
- ▶ 32mm outlet
- ▶ The Lowara 2HMS3 Pump can be used with up to 3 Bosch Commercial Hot Water Systems (32 or 32C)

#Not available in New Zealand.

### Typical Bosch Manifold Tank Kit Installation

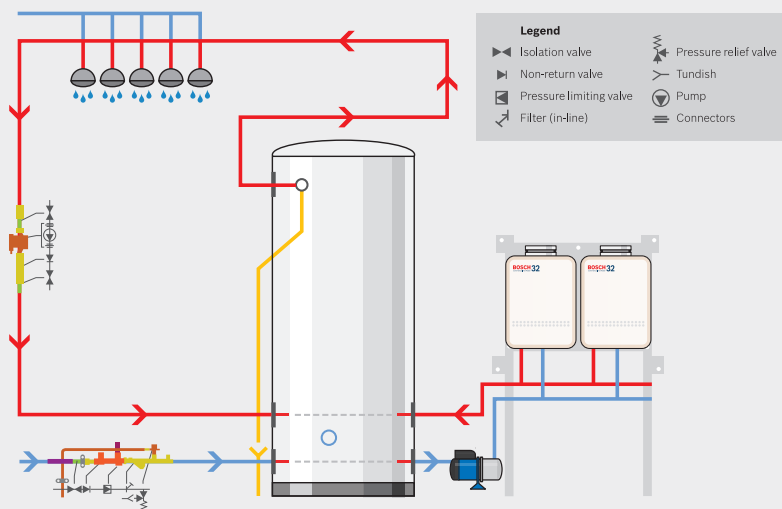

Note: Diagram is for illustration purposes only and is not drawn to scale.

### Specifications

Part Number	Description	Components	Component Description
BMTP2NG BMTP2LP	Bosch Manifold Tank Kit incl 2 x 32 Units	2 x 32 Manifolde 1 x 315C232LR 1 x ALPHASTATPLUSWR 1 x BCPK32 1 x BFMK32	Manifold Pack Module incl 2 x 32 units Dual plumbed 315L st/steel tank Senztek digital thermostat Commercial pump kit Floor mounting kit for manifold frame
BMTP3NG BMTP3LP	Bosch Manifold Tank Kit incl 3 x 32 Units	3 x 32 Manifolde 315C232LR 1 x ALPHASTATPLUSWR 1 x BCPK32 1 x BFMK32	Manifold Pack Module incl 3 x 32 units Dual plumbed 315L st/steel tank Senztek digital thermostat Commercial pump kit Floor mounting kit for manifold frame
BCCP2NG BCCP2LP	Bosch Commercial Condensing Tank Kit incl 2 x 32C Units	2 x 32C Manifolde 315C232LR 1 x ALPHASTATPLUSWR 1 x BCPK32 1 x BFMK32	Manifold Pack Module incl 2 x 32C units Dual plumbed 315L st/steel tank Senztek digital thermostat Commercial pump kit Floor mounting kit for manifold frame
BCCP3NG BCCP3LP	Bosch Commercial Condensing Tank Kit incl 3 x 32C Units	3 x 32C Manifolde 315C232LR 1 x ALPHASTATPLUSWR 1 x BCPK32 1 x BFMK32	Manifold Pack Module incl 3 x 32C units Dual plumbed 315L st/steel tank Senztek digital thermostat Commercial pump kit Floor mounting kit for manifold frame

# Bosch Commercial Accessories

Choose from a range of commercial accessories, allowing you to customise your installation.



### Main Remote Controller

RCM3211

- ▶ On / Off button
- ▶ Time display (current time)
- ▶ Temperature (eg 40°C)
- ▶ “Burner on” display when in use
- ▶ “Circulation mode on” display (32Q)
- ▶ Maximum of 3 controllers can be fitted to the 32, 32Q, and the 32C. Eg, 1 Main Controller and up to 2 Sub Controllers
- ▶ Full diagnostic display



### Sub Controller

RCS3211

- ▶ On / Off button
- ▶ Temperature display (eg 40°C)
- ▶ “Burner on” display when in use
- ▶ “Priority” indicator
- ▶ Error display
- ▶ Suitable for 32, 32Q, and 32C



### Vent Cap

KMVC-100

- ▶ 32 Series only (32 and 32Q)\*
- ▶ For external installations only

\*For 32C applications, the BCVC-100C Vent Cap is to be used, see page 8.

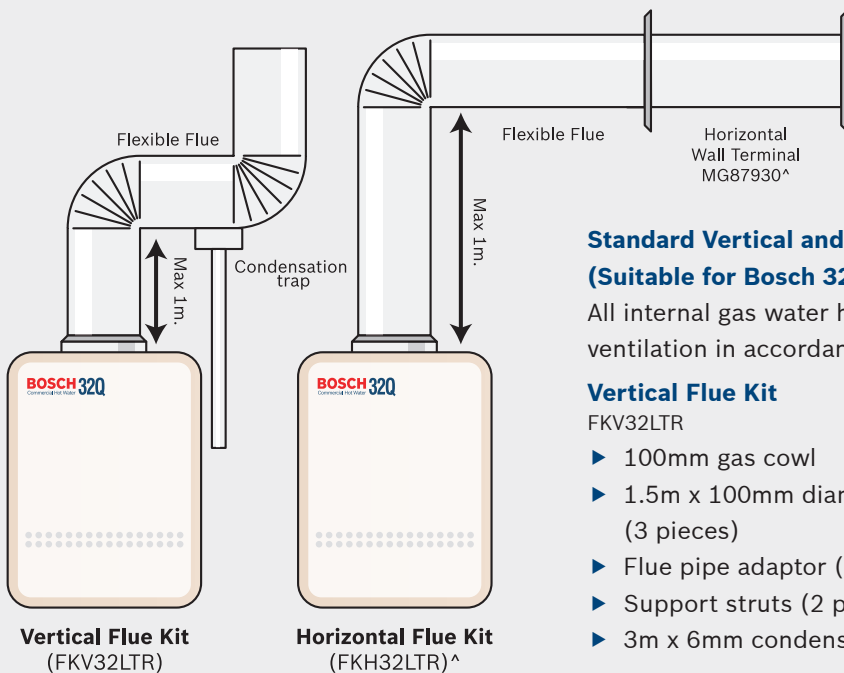

### Standard Vertical and Horizontal Flue Kit<sup>^</sup> (Suitable for Bosch 32 and 32Q only)

All internal gas water heaters must be flued and installed with adequate ventilation in accordance with AS5601 or NZ5261.

#### Vertical Flue Kit

FKV32LTR

- ▶ 100mm gas cowl
- ▶ 1.5m x 100mm diameter gas flex (3 pieces)
- ▶ Flue pipe adaptor (3 pieces)
- ▶ Support struts (2 pieces)
- ▶ 3m x 6mm condensation hose

#### Horizontal Flue Kit

FKH32LTR<sup>^</sup>

- ▶ 100mm diameter flexible flue, 5m long
- ▶ Flue sleeve
- ▶ Adjustable wall penetration sleeve (2 pieces)
- ▶ Clamp

The maximum flue length for a vertical flue with 1 elbow is 13m.

For flueing information for the Bosch Commercial Condensing 32C appliance, see page 8.

<sup>^</sup>Horizontal Flue Terminal (MG87930) required with horizontal flue kit and this must be ordered separately.



Bosch offers versatile commercial solutions to suit your unique requirements, including solar contributions. Why don't you add Bosch to your specification today?



# Commercial **Manifold Pack Accessories**

Bosch Commercial Manifold Packs have a range of inclusions and options to suit your unique specification.

## Standard Inclusions



### Floor Mount Kit

BFMK32

- ▶ Free standing system for Bosch Manifold Pack
- ▶ Standard with Floor Mount Manifold Pack



### Cable for system controller

0700073

- ▶ 3 metres in length
- ▶ Standard with all Manifold Packs



### Connection Kit

BCK32

- ▶ Connects 2 manifolded modules side by side
- ▶ 40mm brass barrel unions
- ▶ Standard with Manifold Packs of 4 to 6 units

## Optional Accessories



### Senztek Digital Thermostat

ALPHASTATPLUSWR

- ▶ Standard with Manifold Tank Kits
- ▶ Programmable
- ▶ Saves power, saves money
- ▶ Large 20mm soft green digital LED display with 8 status lights
- ▶ User adjustable water temperature settings
- ▶ Biosafe function for legionella protection

- ▶ High quality, efficiency, reliability and +/-1°C accuracy
- ▶ Stainless steel, water resistant temperature sensor
- ▶ Sensor diagnostics and smart shutdown
- ▶ Easy to install with external mounting holes
- ▶ Complies with safety and EMC standards
- ▶ Enclosure and cable UV resistant
- ▶ 16Amp relay standard with permanent wiring



### Commercial Pump Kit\*

BCPK32

#### Components:

- ▶ Standard with Manifold Tank Kits
- ▶ Lowara 2HMS3 pump with lead, which plugs into digital thermostat (ALPHASTATPLUSWR)
- ▶ Pipes with weatherproof insulation
- ▶ Connectors

\*Not available in New Zealand.



#### System Controller\*

KMSC201

- ▶ Standard with Manifold Packs of 3 to 6 units
- ▶ Suitable for 32 and 32C only
- ▶ Sophisticated unit rotation for extended system lifespan

#### Quick Connection Cable\*

KMQC0703339

- ▶ Standard with 2-unit Manifold Packs
- ▶ Suitable for 32 and 32C only

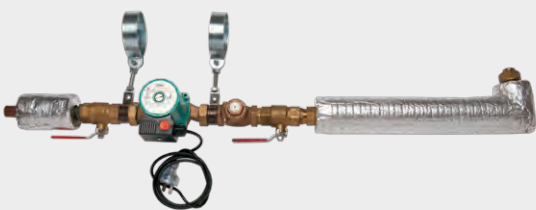

#### Ring Main Kit#

BRMK32

- ▶ Connects Bosch Manifold Pack to a Ring Main
- ▶ Components include: Wilo Star Z20/7-3 pump, non-return valve, isolation valve, connectors, and pipework

#Not available in New Zealand.

\*When using a Quick Connection Cable or System Controller, a Main Controller (RCM3211) must be fitted, see page 14.





# Bosch Professional Packs#



Simply connect to water, gas and electricity and the Bosch Professional Pack is ready to go – no assembly required.

## Components:

- ▶ Bosch 315L Stainless Steel Commercial Tank (C315C220T), with 32mm lefthand side connections and 20mm connections at front
- ▶ Bosch 32 Commercial Hot Water System (KM3211WHNG/LP)
- ▶ Stainless steel Grundfos Pump
- ▶ Digital Thermostat (ALPHASTATPLUSWR)
- ▶ Shroud

#Not available in New Zealand.



**Model shown – C315T32WHNG**

## Features:

- ▶ Up to 1260 litres at 50°C rise in first hour
- ▶ Ease of maintenance
- ▶ Simple installation as product is pre-assembled
- ▶ Internal\* or external\*\* installation
- ▶ Space saving, with a centralised system
- ▶ System tailored to your specific needs
- ▶ Mains pressure
- ▶ Improved port sizes and locations
- ▶ Accurate temperature control with the Senztek Digital Thermostat (ALPHASTATPLUSWR)
- ▶ Ideal for apartment blocks and hotels

## Specifications

Part Number	Gas Type	Tank Size	Burner Size
C315T32WHLP	LP	315	250 Mj/H
C315T32WHNG	NG	315	250 Mj/H

\*Internal installation of the Bosch Professional Pack requires flueing and adequate ventilation, see page 14.

\*\*External installation of the Bosch Professional Pack requires the KMVC-100 Vent Cap, see page 14.

It's easy to specify the Bosch Professional Pack, because it's pre-assembled and can be installed internally or externally depending on your requirements.



# Bosch Commercial Tanks

The new range of Bosch Stainless Steel Commercial Tanks provide added flexibility for your installation requirements, including a dry well for a Senztek Digital Thermostat (ALPHASTATPLUSWR)\* sensor to be inserted.

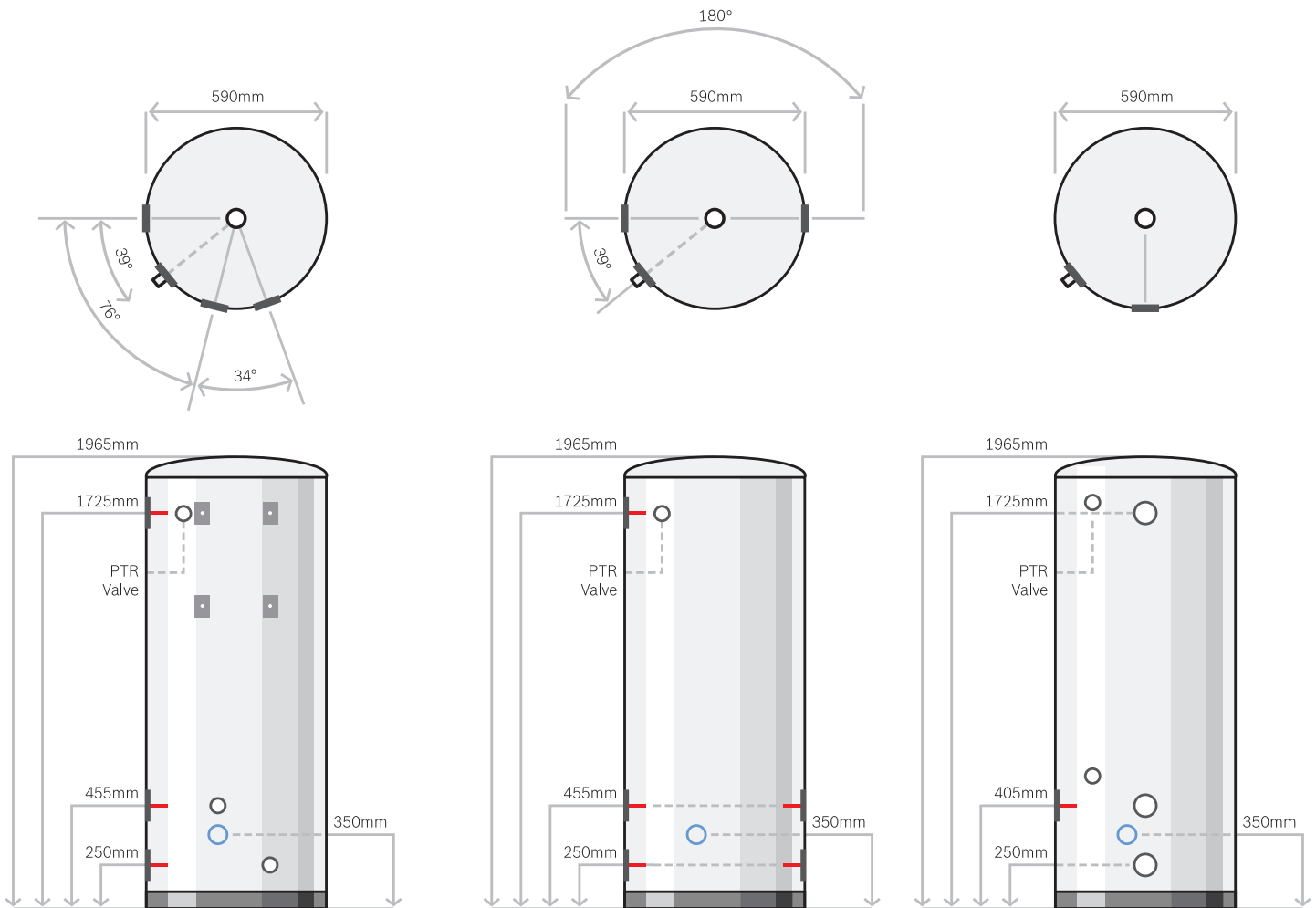

## 315C220T

- ▶ 315 Litre Stainless Steel Commercial Storage Tank
- ▶ 32mm lefthand connections with 20mm connections at front
- ▶ Specifically designed for use in the Bosch Professional Pack (see page 18)
- ▶ Sensor well pocket for Senztek Digital Thermostat (ALPHASTATPLUSWR)\*

## 315C232LR

- ▶ 315 Litre Stainless Steel Commercial Storage Tank
- ▶ Dual plumbed 32mm lefthand and righthand connections
- ▶ Sensor well pocket for Senztek Digital Thermostat (ALPHASTATPLUSWR)\*

## 315C250T

- ▶ 315 Litre Stainless Steel Commercial Storage Tank
- ▶ 50mm connections with a return line port
- ▶ Sensor well pocket for Senztek Digital Thermostat (ALPHASTATPLUSWR)\*

\*Senztek Digital Thermostat (ALPHASTATPLUSWR) not included as standard and must be ordered separately.



# Bosch Commercial System Selection Guide - Tank Burner Combinations

## Bosch 32 Commercial

No. of systems	Commercial Pack Model (32)	Installation location	First hour litres at a 50° C rise	Recovery litres at a 50° C rise	Tank size (L)	No. of Water Heaters	Gas rate (Mj/H)	Apartments mix of 1 & 2 bedroom	Apartments mix of 2 & 3 bedroom	Hotel Beds 1-3 star rated	Hotel Beds 4-5 star	Amenities No. of (AAA) 3 star showers
1	C315T32WHNG or LP	Int* or Ext**	1275	960	315	1 x 250(Mj/H)	250	20	14	58	36	8
1	BMTP2NG or LP	Int* or Ext**	2235	1920	315	2 x 250(Mj/H)	500	35	25	101	63	11
1	BMTP3NG or LP	Int* or Ext**	3195	2880	315	3 x 250(Mj/H)	750	50	35	145	91	19
2	C315T32WHNG or LP	Int* or Ext**	2550	1920	2 x 315	2 x 250(Mj/H)	500	40	25	116	72	12
2	BMTP2NG or LP	Int* or Ext**	4470	3840	2 x 315	4 x 250(Mj/H)	1000	70	48	203	127	23
2	BMTP3NG or LP	Int* or Ext**	6390	5760	2 x 315	6 x 250(Mj/H)	1500	100	70	290	182	35
3	C315T32WHNG or LP	Int* or Ext**	3825	2880	3 x 315	3 x 250(Mj/H)	750	60	42	173	109	17
3	BMTP2NG or LP	Int* or Ext**	6705	5760	3 x 315	6 x 250(Mj/H)	1500	105	74	304	191	41
3	BMTP3NG or LP	Int* or Ext**	9585	8640	3 x 315	9 x 250(Mj/H)	2250	152	106	435	273	59
4	C315T32WHNG or LP	Int* or Ext**	5100	3840	4 x 315	4 x 250(Mj/H)	1000	80	56	231	145	31
4	BMTP2NG or LP	Int* or Ext**	8940	7680	4 x 315	8 x 250(Mj/H)	2000	142	100	406	255	55
4	BMTP3NG or LP	Int* or Ext**	12780	11520	4 x 315	12 x 250(Mj/H)	3000	204	142	580	365	78

## Bosch 32C Commercial Condensing

No. of systems	Commercial Pack Model (32C)	Installation location	First hour litres at a 50° C rise	Recovery litres at a 50° C rise	Tank size (L)	No. of Water Heaters	Gas rate (Mj/H)	Apartments mix of 1 & 2 bedroom	Apartments mix of 2 & 3 bedroom	Hotel Beds 1-3 star rated	Hotel Beds 4-5 star	Amenities No. of (AAA) 3 star showers
1	BCCP2NG or LP	Int* or Ext**	2235	1920	315	2 x 217(Mj/H)	434	35	25	101	63	11
1	BCCP3NG or LP	Int* or Ext**	3195	2880	315	3 x 217(Mj/H)	651	50	35	145	91	19
2	BCCP2NG or LP	Int* or Ext**	4470	3840	2 x 315	4 x 217(Mj/H)	868	70	48	203	127	23
2	BCCP3NG or LP	Int* or Ext**	6390	5760	2 x 315	6 x 217(Mj/H)	1302	100	70	290	182	35
3	BCCP2NG or LP	Int* or Ext**	6705	5760	3 x 315	6 x 217(Mj/H)	1302	105	74	304	191	41
3	BCCP3NG or LP	Int* or Ext**	9585	8640	3 x 315	9 x 217(Mj/H)	1953	152	106	435	273	59
4	BCCP2NG or LP	Int* or Ext**	8940	7680	4 x 315	8 x 217(Mj/H)	1736	142	100	406	255	55
4	BCCP3NG or LP	Int* or Ext**	12780	11520	4 x 315	12 x 217(Mj/H)	2604	204	142	580	365	78

### Please note:

- 1st hour delivery = Tank volume + 960 litres per commercial Unit (32 or 32C).
- 1st hour calculations for apartments: 1 bedroom 50 litres, 2 bedrooms 75 litres, 3 bedrooms 105 litres.
- Amenities: 6 x 27 litres of hot water per shower per hour.
- Hotels: 1-3 star 22 litres, 4-5 star 35 litres, which allows for showers, meals and laundry.

\*Internal installations require flueing and adequate ventilation. Refer to page 14 for the Bosch 32 or page 8 for the Bosch 32C flueing components.

\*\*External installations require a Vent Cap. Refer to page 14 for the Bosch 32 Vent Cap or page 8 for the Bosch 32C Vent Cap.

# Bosch Product Specifications



## Bosch 32 Commercial Manifold Pack

	Wall Mount					Floor Mount				
Part Number	WBM2NGSK / WBM2LPSK	WBM3NGSK / WBM3LPSK	WBM4NGSK / WBM4LPSK	WBM5NGSK / WBM5LPSK	WBM6NGSK / WBM6LPSK	FBM2NGSK / FBM2LPSK	FBM3NGSK / FBM3LPSK	FBM4NGSK / FBM4LPSK	FBM5NGSK / FBM5LPSK	FBM6NGSK / FBM6LPSK
Installation	Int* or Ext**	Int* or Ext**	Int* or Ext**	Int* or Ext**	Int* or Ext**	Int* or Ext**	Int* or Ext**	Int* or Ext**	Int* or Ext**	Int* or Ext**
Ignition	Electronic	Electronic	Electronic	Electronic	Electronic	Electronic	Electronic	Electronic	Electronic	Electronic
L/min (25°C rise)	64	96	128	160	192	64	96	128	160	192
Min. operating inlet water pressure (kPa)	200	200	200	200	200	200	200	200	200	200
Max. inlet water pressure (kPa)	900	900	900	900	900	900	900	900	900	900
Mj/H	500	750	1000	1250	1500	500	750	1000	1250	1500
Temperature Range	37°C - 80°C	37°C - 80°C	37°C - 80°C	37°C - 80°C	37°C - 80°C	37°C - 80°C	37°C - 80°C	37°C - 80°C	37°C - 80°C	37°C - 80°C
Min. Flow (L/Min)	3.5	3.5	3.5	3.5	3.5	3.5	3.5	3.5	3.5	3.5
Min. constant water pressure for Max flow (kPa)	200	200	200	200	200	200	200	200	200	200
Antifrost	Standard	Standard	Standard	Standard	Standard	Standard	Standard	Standard	Standard	Standard
Gas Type	NG/LPG	NG/LPG	NG/LPG	NG/LPG	NG/LPG	NG/LPG	NG/LPG	NG/LPG	NG/LPG	NG/LPG
Parts & Labour Warranty <sup>^</sup>	2 Years	2 Years	2 Years	2 Years	2 Years	2 Years	2 Years	2 Years	2 Years	2 Years
Heat Exchanger Warranty (part only) <sup>^</sup>	5 Years	5 Years	5 Years	5 Years	5 Years	5 Years	5 Years	5 Years	5 Years	5 Years
Pipe Connection Size (mm)	40	40	40	40	40	40	40	40	40	40
Controller included	RCM3211	RCM3211	RCM3211	RCM3211	RCM3211	RCM3211	RCM3211	RCM3211	RCM3211	RCM3211
Quick Connection Cable included	KMQC0703339	No	No	No	No	KMQC0703339	No	No	No	No
System controller included	No	KMSC201	KMSC201	KMSC201	KMSC201	No	KMSC201	KMSC201	KMSC201	KMSC201
Cable for system controller included	No	0700073 x 2	0700073 x 3	0700073 x 4	0700073 x 5	No	0700073 x 2	0700073 x 3	0700073 x 4	0700073 x 5
Manifold pack dimensions										
Height x Width x Depth (mm)	1540 x 993 x 286	1540 x 1468 x 286	Combination of 2 x WBM2	Combination of 1 x WBM2 & 1 x WBM3	Combination of 2 x WBM3	1540 x 993 x 286	1540 x 1468 x 286	Combination of 2 x FBM2	Combination of 1 x FBM2 & 1 x FBM3	Combination of 2 x FBM3
Crate										
Height x Width x Depth (mm)	300 x 1100 x 1100	300 x 1500 x 1100	300 x 1100 x 1100	300 x 1100 x 1100	300 x 1500 x 1100	300 x 1100 x 1100	300 x 1500 x 1100	300 x 1100 x 1100	300 x 1100 x 1100	300 x 1500 x 1100
Combined carton weight (kg)	94	130	188	224	260	100	140	196	230	266

\*Internal installations require flueing and adequate ventilation, see page 14.

\*\*External installations require the KMVC-100 Vent Cap, see page 14.

<sup>^</sup>Commercial applications only.



## Bosch 32C Commercial Condensing Manifold Pack

	Wall Mount					Floor Mount				
<b>Part Number</b>	WBCC2NGSK /WBCC2LPSK	WBCC3NGSK /WBCC3LPSK	WBCC4NGSK /WBCC4LPSK	WBCC5NGSK /WBCC5LPSK	WBCC6NGSK /WBCC6LPSK	FBCC2NGSK /FBCC2LPSK	FBCC3NGSK /FBCC3LPSK	FBCC4NGSK /FBCC4LPSK	FBCC5NGSK /FBCC5LPSK	FBCC6NGSK /FBCC6LPSK
<b>Part Number (50°C limited)#</b>	WBCC2NG5SK /WBCC2LP5SK	WBCC3NG5SK /WBCC3LP5SK	WBCC4NG5SK /WBCC4LP5SK	WBCC5NG5SK /WBCC5LP5SK	WBCC6NG5SK /WBCC6LP5SK	FBCC2NG5SK /FBCC2LP5SK	FBCC3NG5SK /FBCC3LP5SK	FBCC4NG5SK /FBCC4LP5SK	FBCC5NG5SK /FBCC5LP5SK	FBCC6NG5SK /FBCC6LP5SK
<b>Installation</b>	Int* or Ext**	Int* or Ext**	Int* or Ext**	Int* or Ext**	Int* or Ext**	Int* or Ext**	Int* or Ext**	Int* or Ext**	Int* or Ext**	Int* or Ext**
<b>Ignition</b>	Electronic	Electronic	Electronic	Electronic	Electronic	Electronic	Electronic	Electronic	Electronic	Electronic
<b>L/min (25°C rise)</b>	64	96	128	160	192	64	96	128	160	192
<b>Min. operating inlet water pressure (kPa)</b>	200	200	200	200	200	200	200	200	200	200
<b>Max. inlet water pressure (kPa)</b>	900	900	900	900	900	900	900	900	900	900
<b>Mj/H</b>	434	651	868	1085	1302	434	651	868	1085	1302
<b>Temperature Range</b>	<b>BC3200RA – 55°C factory set</b>   Optional – 50°C, 75°C, 85°C by adjusting harness					Optional – 37°C to 80°C with controller				
	<b>BC3200RA5 – 50°C limited</b>   Optional – 40°C, 42°C by adjusting harness					Optional – 37°C to 50°C with controller#				
<b>Min. Flow (L/min)</b>	3.5	3.5	3.5	3.5	3.5	3.5	3.5	3.5	3.5	3.5
<b>Min. constant water pressure for Max. flow (kPa)</b>	200	200	200	200	200	200	200	200	200	200
<b>Star rating (Thermal Efficiency)</b>	6 (94%)	6 (94%)	6 (94%)	6 (94%)	6 (94%)	6 (94%)	6 (94%)	6 (94%)	6 (94%)	6 (94%)
<b>Antifrost</b>	Standard	Standard	Standard	Standard	Standard	Standard	Standard	Standard	Standard	Standard
<b>Gas Type</b>	NG/LPG	NG/LPG	NG/LPG	NG/LPG	NG/LPG	NG/LPG	NG/LPG	NG/LPG	NG/LPG	NG/LPG
<b>Parts and Labour Warranty^</b>	2 Years	2 Years	2 Years	2 Years	2 Years	2 Years	2 Years	2 Years	2 Years	2 Years
<b>Heat Exchanger Warranty^ (part only)</b>	5 Years	5 Years	5 Years	5 Years	5 Years	5 Years	5 Years	5 Years	5 Years	5 Years
<b>Pipe Connection Size (mm)</b>	40	40	40	40	40	40	40	40	40	40
<b>Controller included</b>	RCM3211	RCM3211	RCM3211	RCM3211	RCM3211	RCM3211	RCM3211	RCM3211	RCM3211	RCM3211
<b>Quick Connection Cable included</b>	KMQC0703339	No	No	No	No	KMQC0703339	No	No	No	No
<b>System Controller included</b>	No	KMSC201	KMSC201	KMSC201	KMSC201	No	KMSC201	KMSC201	KMSC201	KMSC201
<b>Cable for system controller included</b>	No	0700073 x 2	0700073 x 3	0700073 x 4	0700073 x 5	No	0700073 x 2	0700073 x 3	0700073 x 4	0700073 x 5
<b>Manifold pack dimensions Height x Width x Depth (mm)</b>	1540 x 993 x 286	1540 x 1468 x 286	Combination of 2 x WBCC2	Combination of 1 x WBCC2 & 1 x WBCC3	Combination of 2 x WBCC3	1540 x 993 x 286	1540 x 1468 x 286	Combination of 2 x WBCC2	Combination of 1 x WBCC2 & 1 x WBCC3	Combination of 2 x WBCC3
<b>Crate Height x Width x Depth (mm)</b>	300 x 1100 x 1100	300 x 1500 x 1100	300 x 1100 x 1100 (x2)	300 x 1100 x 1100	300 x 1500 x 1100 (x2)	300 x 1100 x 1100	300 x 1500 x 1100	300 x 1100 x 1100 (x2)	300 x 1100 x 1100	300 x 1500 x 1100 (x2)
<b>Combined carton weight (Kg)</b>	110	154	220	264	308	110	154	220	264	308

\*Internal installations require flueing and adequate ventilation, see page 8.

\*\*External installations require the BCVC-100C Vent Cap, see page 8.

^Commercial applications only.

#Not available in New Zealand.



**Robert Bosch (Australia) Pty Ltd**

**Melbourne**

1555 Centre Road  
Clayton Victoria 3168  
P (03) 9541 5555  
F (03) 9541 5595  
Sales Hotline: 1300 30 70 37  
Sales Fax: 1300 30 70 38  
**[www.bosch-climate.com.au](http://www.bosch-climate.com.au)**

**New Zealand**

Sales Hotline: 0800 54 33 52  
Sales Fax: 0800 54 33 55  
**[www.bosch-climate.com.nz](http://www.bosch-climate.com.nz)**